

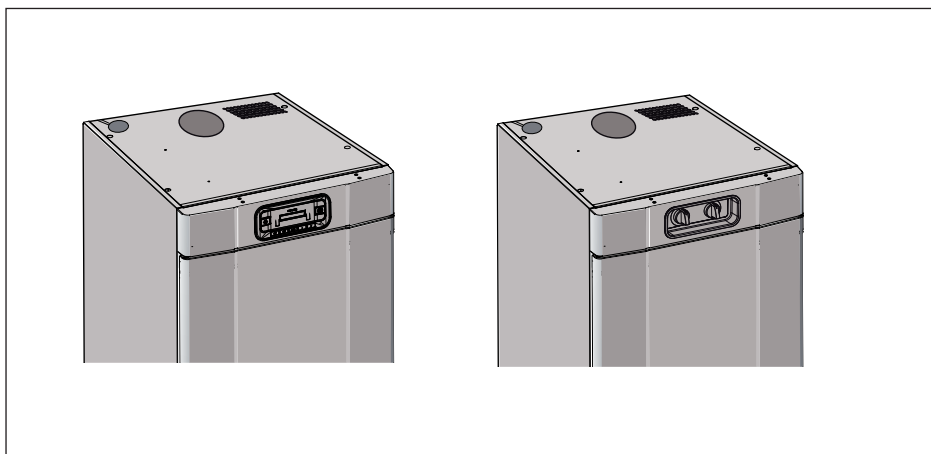

## Installation and User Manual



# Drying Cabinet

## **ETS 1700E/1900E**

## **ETS 1700 / 1900**

**ENG**

Doc. No: 427000723

*Keep this user manual in a safe place, so that it will always be on hand for future reference.*

*Dear NIMO customer,*

*Congratulations on making an excellent choice and welcome to the NIMO family. NIMO is a global family with its roots in Sweden.*

*NIMO thanks you for your confidence and hopes that you will enjoy using your new drying cabinet.*

*A good drying cabinet should be well designed, dry clothes well, have a low environmental impact, be user friendly, save time, have a long life and be reliable. NIMO offers you all of these features.*

*When you buy a NIMO product you can be sure that the inside is as good as the outside and that the ethics and morality that go into building this product are just as high as the quality and functionality you are getting. That's what Swedish quality is all about.*

*Before using the product for the first time, please read the user instructions and the advice on caring for the product. This will help you get the best possible results from your product and all its functions.*

*If you have any questions, don't hesitate to call us or contact us via our website.*

*Best wishes from Sweden and the NIMO team.*

## **ARTICLE AND SERIAL NUMBER**

See page 23

**Manufacturer:** NIMO-VERKEN AB Box124  
S-548 22 HOVA  
Sweden  
Ph +46 (0) 506 488 00  
Fax +46 (0) 506 488 10  
nimo@nimoverken.com  
www.nimoverken.com



Doc. No: 427000723 Rev. 03

# CONTENTS

---

<b>ABOUT THIS USER MANUAL</b>	<b>4</b>	<b>USING FOR THE FIRST TIME</b>	<b>16</b>
<b>SAFE USE</b>	<b>5</b>	<b>POSITIONING THE WASHING</b>	<b>17</b>
<i>USES</i>	5	<i>USER TIPS</i>	17
<i>TECHNICAL SAFETY</i>	5	<i>AIRFLOW</i>	17
<b>FOR A GOOD ENVIRONMENT</b>	<b>6</b>	<b>USING THE ETS 1700E / ETS 1900E DRYING CABINET</b>	<b>18</b>
<i>PACKAGING MATERIAL</i>	6	<i>CONTROL PANEL</i>	18
<i>MANAGEMENT OF END-OF-LIFE     DRYING CABINET</i>	6	<i>DISPLAY</i>	18
<b>DESCRIPTION OF THE DRYING CABINET</b>	<b>7</b>	<i>DRYING PROGRAMME</i>	19
<b>INSTALLATION</b>	<b>8</b>	<i>DRYING FUNCTION</i>	19
<i>UNPACKING</i>	8	<i>BREAKDOWNS</i>	21
<i>FITTING THE DOOR HANDLE</i>	9	<i>AUTOMATIC PROGRAMMES –     SETTING THE PARAMETERS</i>	21
<i>REHANGING THE DOOR</i>	9	<b>USING THE ETS 1700 / 1900 DRYING CABINET</b>	<b>22</b>
<i>POSITIONING / FIXING THE CABINET</i>	12	<i>SETTINGS</i>	<b>22</b>
<i>EXHAUST / SUPPLY AIR</i>	13	<b>CARE</b>	<b>23</b>
<i>EXHAUST CONNECTION</i>	13	<i>CLEANING</i>	23
<i>ELECTRICAL CONNECTIONS</i>	15	<i>SERVICE</i>	23
		<b>TECHNICAL DATA ETS 1700E / 1900E</b>	<b>24</b>
		<b>TECHNICAL DATA ETS 1700 / 1900</b>	<b>25</b>
		<b>PARAMETER ADJUSTMENT ETS 1700E / 1900E</b>	<b>26</b>
		<i>INTRODUCTION</i>	26
		<i>PARAMETER ADJUSTMENT</i>	27

## ***ABOUT THIS USER MANUAL***

---

The contents of this user manual describe the **drying cabinet's functions** and **how it should be used**. The manual also includes instructions for **installation** and **maintenance**.

*This drying cabinet meets applicable safety requirements. Incorrect use may, however, lead to injuries and damage to property.*

*This advice on safe use is intended to enable you to avoid incorrect use and to reduce the risk of unnecessary accidents, and should be read prior to installation and use of the drying cabinet.*

### USES

- ❑ **CAUTION!** *This equipment is only intended to be used to dry fabrics washed in water.*
- ❑ *The drying cabinet can be used by children aged 8 or over and persons (including children) with physical, sensory or mental impairments, provided they have received guidance or information on how to use the drying cabinet safely and understand the risks that can occur.*
- ❑ *Do not allow children to play in or on the drying cabinet. Keep an eye on children when they are in the immediate vicinity of the cabinet.*
- ❑ *Cleaning and maintenance must not be carried out by children without supervision.*

### TECHNICAL SAFETY

- ❑ *Check the drying cabinet for visible damage before installing it. A damaged drying cabinet must not be used as it may pose a hazard.*
- ❑ *The drying cabinet must only be connected to a grounded socket installed in accordance with applicable safety regulations. After installation the wall socket must be accessible so that the power supply to the drying cabinet can be disconnected at any time.*
- ❑ *Check that the data on the drying cabinet's data plate (fuse, voltage and frequency) is in agreement with the mains supply at the place where the cabinet is installed.*
- ❑ *The drying cabinet must not be connected using an extension cable as the necessary safety cannot be guaranteed (risk of overheating).*
- ❑ *If the mains lead is damaged it must be immediately replaced, and only by the manufacturer, the manufacturer's service agent or similar qualified persons to avoid danger.*

## **FOR A GOOD ENVIRONMENT**

---

### **PACKAGING MATERIAL**

The packaging that protects the drying cabinet against damage in transit has been chosen with concern for the environment in mind and is therefore recyclable.

Recycled packaging means reduced consumption of raw materials and lower levels of waste.

### **MANAGEMENT OF END-OF-LIFE DRYING CABINET**

When the drying cabinet has reached the end of its life, it must be taken to a recycling centre for disposal. Many parts can be re-used, but the cabinet also contains other material that must be handled correctly. You should therefore never dispose of a drying cabinet or parts of a cabinet with the domestic refuse as this can lead to health risks and harm the environment.



Take the end-of-life drying cabinet to a recycling station instead. Check with your dealer if necessary.

All the plastic parts of the drying cabinet are marked with internationally standardised symbols. The parts can therefore be recycled in an environmentally friendly way by waste separation.

## DESCRIPTION OF THE DRYING CABINET

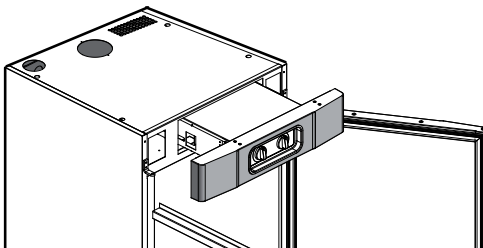
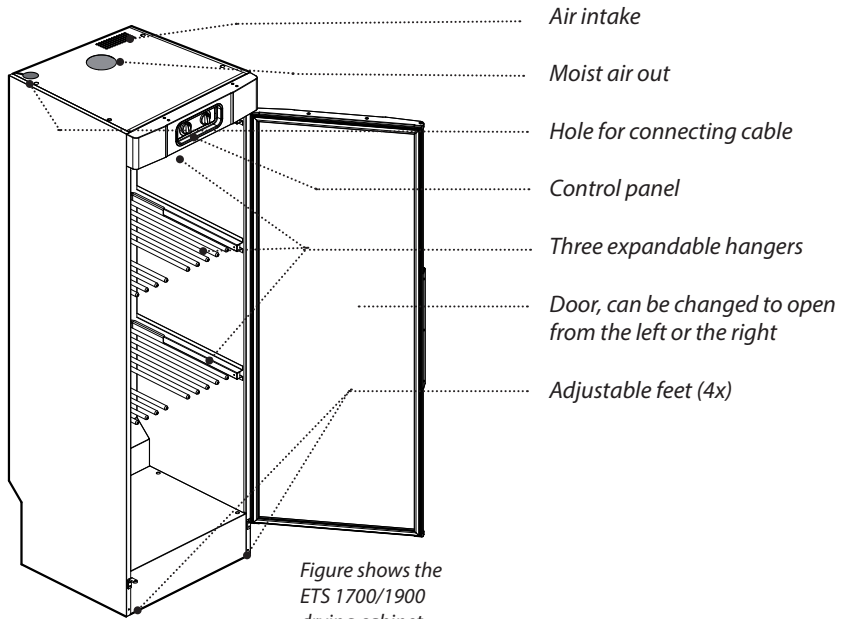

### **Service module**

The heating and fan components are combined in a removable service module.

# INSTALLATION

## UNPACKING



The drying cabinet should be handled carefully if it is only standing on its wooden pallet. **RISK OF TIPPING OVER**

After unpacking, check that the goods are in good condition. Damage, faults and any missing parts should be immediately reported to your dealer.

Check that the goods have not been damaged in transit. Any damage should be reported to your dealer within 7 days.









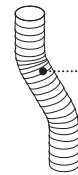

Check that all transportation aids have been removed before connecting the dryer.

Packaging materials such as plastic and styrofoam should be kept out of the reach of children.

### Complete delivery should include:

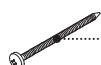
- A cabinet with a fan unit installed
- Assembly kit
- Installation and User Manual

### Assembly kit:

	Draught stabiliser	Qty. 1		Nylon plug	Qty. 2
	Hose	1		Spacer 8.2x12x15	2
	Sleeve	1		Cover plug, white	4
	Screw TRX 5x70 fzk	2		Door handle with fixing screws	1
	Washer NB 5x25	2		Allen wrench	1



### FITTING THE DOOR HANDLE

Fit the door handle with the fixing screws supplied.

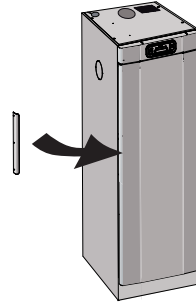

### REHANGING THE DOOR

The door can be hung on the right or to the left.

#### A LOWER HINGES ARE PRE-MOUNTED ON BOTH SIDES

- 1 Lay the drying cabinet on its back.
- 2 Undo the hinge pin from the bottom hinge (1) and lift off the door.
- 3 Undo the plastic plug and insert it in the opposite-side lower hinge.
- 4 Undo the hinge pin from the top hinge (2) and place it on the opposite side.
- 5 Rotate the door, align and secure the door with the lower hinge pin (1).

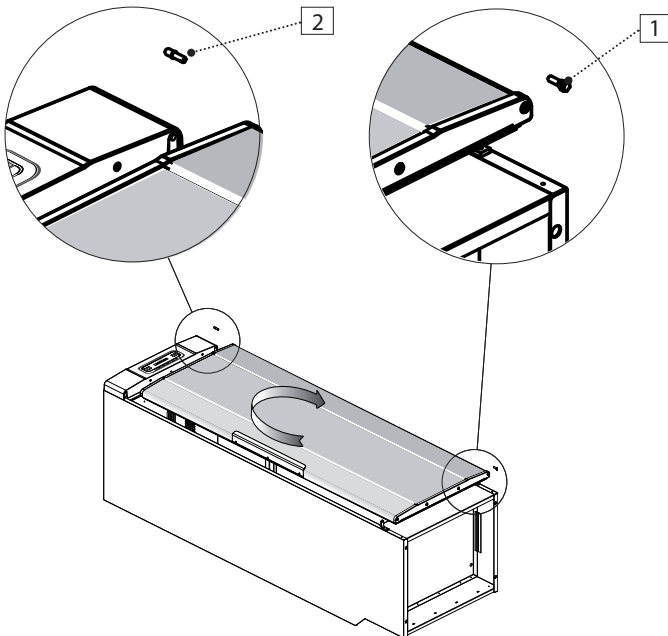

# INSTALLATION

## **B NO LOWER HINGE ON THE OPPOSITE SIDE**

Some models do not have a lower hinge mounted on both sides. In this case the existing hinges must be moved to the required side. The hinge is attached with two screws and threaded washers as illustrated.

Note that the washer is not attached to the cabinet frame.

### ***Rehanging the door when the appliance is resting on its back***

- 1 Undo the hinge screws (3).
- 2 Screw the threaded washer back on (4). On the opposite side there is a threaded washer already pre-mounted.
- 3 Mount the hinge in its new position.
- 4 Undo the hinge pin from the top hinge (2) and place it on the opposite side.
- 5 Rotate the door, align and secure the door with the lower hinge pin (1).

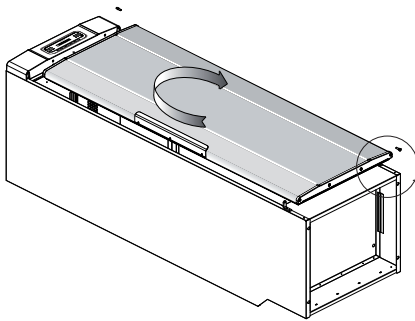

*After the hinge has been mounted on the opposite side, threaded washers must be refitted in their former position. This increases the stability of the cabinet.*

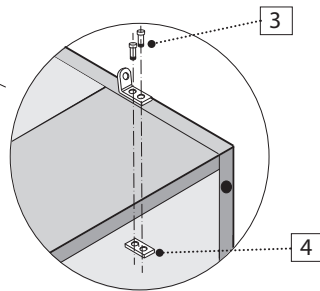

### ***Rehanging the door when the cabinet is fixed to the wall***

The door can also be rehanged when the cabinet is already bolted to the wall and thus cannot be laid on its back.

- 1** Undo the lower hinge pin **(1)** from the bottom hinge and lift off the door. The pin is fastened using a No. 10 sized key.
- 2** Undo and unscrew the upper of the two hinge screws **(3)** and loosen the lower one a little. Rotate the hinge to the side. Refit the upper screw.
- 3** Undo the lower mounting screw and remove the hinge. Refit the screw.
- 4** Mount the hinge in its new position in reverse order, i.e. start by securing the hinge with the lower screw. This prevents the threaded washer from becoming loose which could make it difficult to access the inside of the base.
- 5** Undo the hinge pin from the top hinge **(2)** and place it on the opposite side.
- 6** Rotate the door, align and secure the door with the lower hinge pin **(1)**.

# INSTALLATION

## POSITIONING / FIXING THE CABINET

The drying cabinet is only designed for operation indoors in a dry environment .

The drying cabinet should not be installed in a location where high pressure water is used for cleaning.

- The drying cabinet should stand **level on a flat surface** and rest on all four feet.

Use the Allen wrench provided, and correct the position of all four adjustable feet through the holes in the base plate of the drying cabinet.

Press the four cover plugs down firmly into the holes.

- The drying cabinet must be screwed to the wall to prevent tipping.

**1** Open the front door and drill 8 mm holes in the wall through the two pre-drilled holes in the rear of the drying cabinet.

**2** Insert plastic plugs into the holes in the wall. Thread the spacer onto the screw and install with a washer as shown in the illustration. Screws are supplied in the assembly kit.

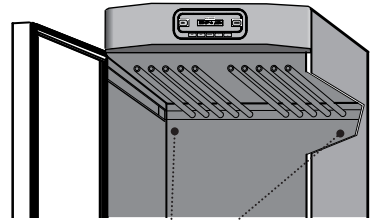
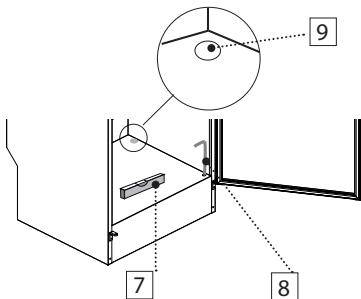

1  
Figure shows the ETS 1700E/1900E drying cabinet

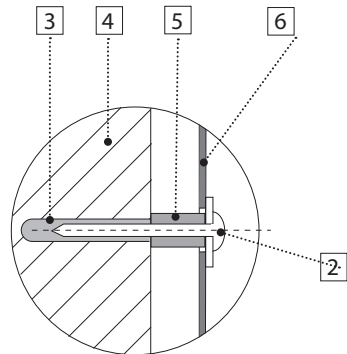

1. Pre-drilled holes
2. Attachment screw with washer
3. Plastic plug
4. Wall behind the drying cabinet
5. Spacer
6. Drying cabinet back wall
7. Spirit level
8. Allen wrench
9. Cover plug

**WARNING** The drying cabinet should not be used without being screwed to the wall due to risk of tipping forwards.

## EXHAUST / SUPPLY AIR

When the drying cabinet is working, about 45 m<sup>3</sup> of moist is are evacuated per hour. This air is taken from the room where the dryer is sited. Hence make sure air can enter the room to replace the moist air leaving.

### EXHAUST CONNECTION

The drying cabinet should be connected to a standard exhaust air ventilation system.

**The drying cabinet can be connected to an exhaust duct in two ways: either with a draught stabilizer or rigidly connected to a mechanical exhaust air ventilation system.**

If the drying cabinet is to be connected to an existing ventilation system, a draught stabilizer must always be used, so that the general ventilation in the room is not affected.

Only use a rigid connection when a separate exhaust air duct has been provided for the drying cabinet. The air flow in the exhaust duct should be adjusted to 45 m<sup>3</sup>/hour.

**The drying cabinet has been tested and set at the factory for connection with a draught stabilizer.**

#### 1. By means of a draught stabilizer

- ❑ Fit the sleeve supplied to the hose. Affix the sleeve and hose to the dryer top.

Connect the other end of the hose to the **draught stabilizer** which should then be firmly attached to the exhaust valve in the room.

*The drying cabinet must not be connected to a fireplace duct.*

*The air intake must not be blocked.*

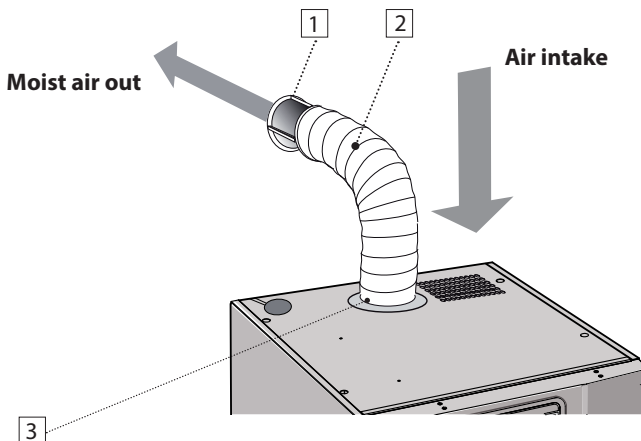

1. Draught stabilizer
2. Hose
3. Sleeve

# INSTALLATION

## 2. Permanently installed and connected to a mechanical exhaust air ventilation system

When the drying cabinet is permanently connected to the evacuation duct, the whole room is ventilated by way of the drying cabinet.

*The insert is not supplied.*

*The air intake must not be blocked.*

- ❑ Fit the sleeve supplied to the hose. Affix the sleeve and hose to the dryer top.

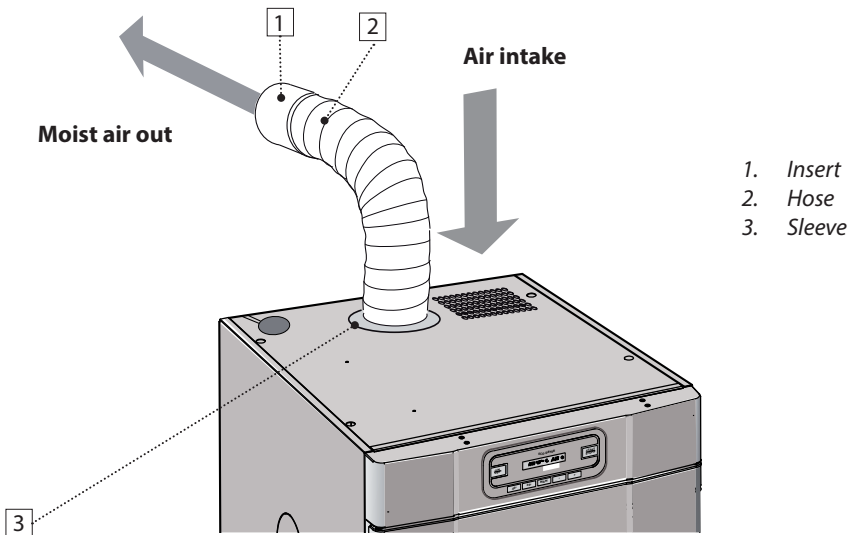

### ELECTRICAL CONNECTIONS

The drying cabinet should be connected to a 230 V single-phase 50 - 60 Hz grounded socket.

The drying cabinet is supplied ready for connection with a cable with a grounded plug.

If the power cable is damaged in any way, it must be replaced. Genuine replacement power cables are available from your dealer.

**NOTE** *Replacement power cables should only be replaced by a qualified electrician!*

*The drying cabinet should be connected using the plug supplied to a grounded wall socket, and should not be permanently connected.*

*The socket should be located where the plug can be easily disconnected when required.*

*Check that the supply current matches that stated on the identification plate and that the mains lead is grounded correctly according to standards in force. We recommend that the mains lead be fitted with a **residual current device (RCD)**.*

*The manufacturer cannot be held liable if the electrical connections are not carried out as prescribed in this manual.*

*Appliance must be connected to a dedicated circuit.*

## **USING FOR THE FIRST TIME**

---



*Read these directions for use before using the drying cabinet for the first time.*

**CAUTION!** *Read the safety instructions on page 5 before using the cabinet.*

- 1** Check that the cabinet is firmly secured to the wall. See page 12.
- 2** Check that no packaging material has been left in place.
- 3** Use a mild detergent and warm water to wash the inside and outside of the drying cabinet. Dry carefully. See also the section headed 'Care' later in the manual.



## POSITIONING THE WASHING

In the cabinet there are three sections with hangers. Every section has a number of bars on which to hang the washing.

The optimised hanging system has extendable hangers.

- ❑ Hang the articles in the drying cabinet according to how much room they require - not according to their weight.
- ❑ For optimum efficiency - do not lay articles flat on the upper hanging section.
- ❑ Long clothes nearest to the walls of the cabinet and shorter ones towards the centre. By hanging the washing in this way the most efficient drying results are attained.
- ❑ Turn up the two lower hanging sections if long clothes are to be dried.
- ❑ Hang gloves, caps, scarves and suchlike on the hanger strips on the inside of the door.
- ❑ Pull the upper hanging hooks forward in order to hang the washing more easily. Return when not in use.
- ❑ Do not overload the drying cabinet. If you do, the washing will become creased and dry uneven. Instead, leave a certain distance between items of washing, if this is possible
- ❑ To avoid transfer of colours, make sure materials do not contact each other.
- ❑ Avoid drying heavy garments at the same time as lighter items as they hold more moisture and have completely different drying times.

- ❑ Remember not to hang knitted articles. These can be needlessly stretched when they are heavy with water.

### USER TIPS

- ❑ Always follow the washing instructions on garments if such instructions are provided.
- ❑ If fabric softener or antistatic product is used, the manufacturer's instructions concerning the utilisation of the product should be followed.
- ❑ Take out washing that is already dry. This reduces drying time for the washing that is left.

### AIRFLOW

The figure shows the airflow in the drying cabinet.

**Keep the area around the evacuation duct clear of dust and dirt.**

**Make sure that the air intake and exhaust air duct are not blocked.**

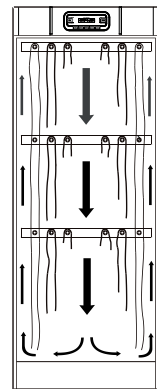

**NOTE** When the cabinet is cold, it can happen that the sealing strip in the door does not close completely. However, this is fully compensated when the cabinet warms up as the sealing strip expands.

# USING THE ETS 1700E / ETS 1900E DRYING CABINET

## CONTROL PANEL

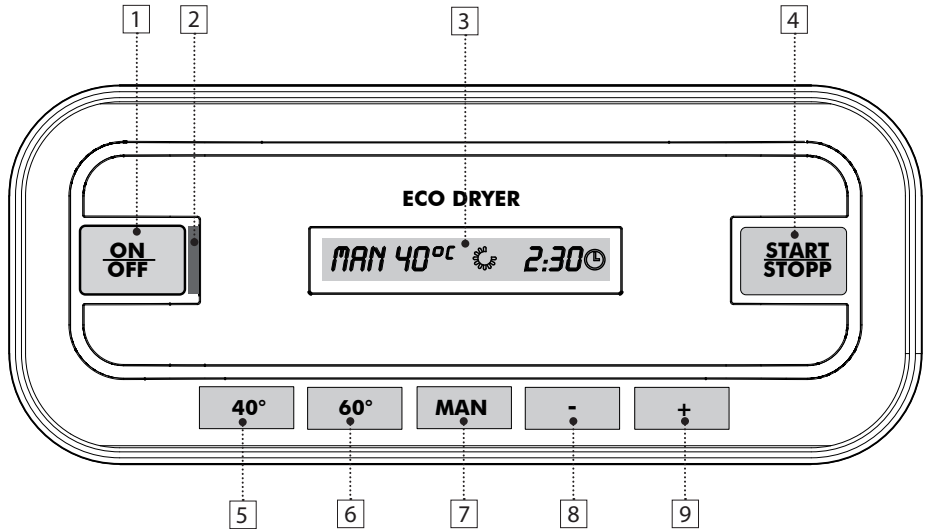

1. Main power switch
2. Main power on indicator - ON
3. Display
4. Programme Start/Stop
5. Automatic programme 40°
6. Automatic programme 60°
7. Manual time control - Step function
8. Reduces standard time for time control
9. Increases standard time for time control

## DISPLAY

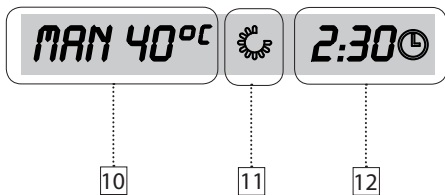

10. Current programme selection
11. Revolving symbol - indicating that the drying process is in progress
12. **With manually programmes:**
  - Programmed drying time
  - Time remaining - when the drying programme has started
12. **With automatic programme:**
  - Time remaining - **N.B.!** Only during the cooling down period

## USING THE ETS 1700E / ETS 1900E DRYING CABINET

---

### **DRYING PROGRAMME**

The drying cabinet is equipped with two automatic programmes:

- AUT 40°**
- AUT 60°**

In addition, the drying cabinet has four time-controlled programmes:

- MAN 30°**
- MAN 40°**
- MAN 60°**
- MAN --°** Only the fan is used during the drying process – No heat

**The automatic programmes** shut off the drying process automatically when the fabrics are dry.

**The manually time-controlled programmes** come to an end after the set time has been counted down.

All the 30°, 40° and 60° programmes finish with a cooling down period of 10 minutes.

### **DRYING FUNCTION**

**Start the drying programme:**

- Last used drying programme.**

Press the main power switch **(1)** to the **ON** position - Indicated by a green light **(2)**

The display shows the last run programme – If this is the one wanted, press the **START/STOP** button **(4)**

Or select another drying programme described below.

- Automatic programmes.**

**Automatic programme 40°**- Press the "40°" button **(5)**, then **START/STOP** **(4)**.

**Automatic programme 60°**- Press the "60°" button **(6)**, then **START/STOP** **(4)**

- Manual time control.**

Using the **MAN** button **(7)** to step through to the desired temperature, 30°, 40°, 60° or only fan. The display shows the standard drying time for the respective programme.

The standard time can, if desired, be increased or reduced with the **"+"** **(8)** or **"-"** **(9)** buttons

After that, the drying programme is started with the **START/STOP** button **(4)**.

## **USING THE ETS 1700E / ETS 1900E DRYING CABINET**

---

### **Door open**

If the door is open when the drying programme is started and the **START/STOP** button (4) is activated, the display shows "**CLOSE DOOR**". Close the door and the selected drying programme will start.

### **During operation**

The revolving symbol on the display indicates that the drying process is in progress.

### **Cooling down**

During the cooling down period, the display shows the text "**COOL**" in the programme selection field.

The time is counted down in the remaining time field (10 minutes).

### **End of programme**

When the cooling down period is complete, the drying process is finished. The display shows the text "**END**" (flashing).

When the **START/STOP** button (4) is pressed or the door is opened, the programme currently running ends and the display shows the last programme used.

**NOTE** *In waiting mode the display is turned off after 10 minutes and lights up when any of the buttons on the control panel are activated or the door is opened.*

### **Stop**

To interrupt the drying process in progress, press **START/STOP (4)**.

### **The door opens**

Should the door open while the drying process is in progress, the heat is shut off (if the interrupted programme uses heat). The fan continues to work for a further 5 minutes. The display shows "**CLOSE DOOR**" and, at the same time, the 5 minute period count down.

If the door is shut within this 5 minute period, the drying process continues, as described below.

### **Automatic programme:**

Starts again from the beginning = longer drying time.

### **Manual time control:**

Goes back and starts from the interrupted count down sequence.

Should the door be left open, the drying process is interrupted after 5 minutes and must be started again manually.

If you wish to interrupt the drying process directly, without the 5 minute period, press **START/STOP (4)**

## **USING THE ETS 1700E / ETS 1900E DRYING CABINET**

---

### **BREAKDOWNS**

#### ***Protection against overheating***

The drying cabinet is equipped with an overheating protection device which trips if the temperature in the cabinet becomes too high. When the protection device trips, the power supply to the drying cabinet main power switch **(1)** is interrupted and the green indicator light **(2)** goes out. In this case the drying cabinet will not start.

When the temperature in the drying cabinet has sunk to an acceptable level, the overheating protection device is reset automatically and the green indicator **(2)** lights up (**N.B.!** If the main power switch **(1)** is on the **ON** position - pressed in).

It takes about 15-20 minutes for the temperature to sink to an acceptable level.

**Therefore**, if the drying cabinet has recently been used and if the green indicator **(2)** will not light up with the main power switch **(1)**, **always wait a minimum of 20 minutes. Then make a new attempt to start it before reporting the fault.**

If repeated breakdowns occur, contact your supplier.

### **AUTOMATIC PROGRAMMES – SETTING THE PARAMETERS**

The two automatic programmes of the drying cabinet can be optimised to match the installation conditions.

To do this, use the control panel to adjust the parameter values for the relevant automatic programme.

Only do this if you think that:

- The washing is not being sufficiently dried
- The washing is being over-dried – excessive drying time.

**See the parameter adjustment instructions on page 26.**

# USING THE ETS 1700 / 1900 DRYING CABINET

---

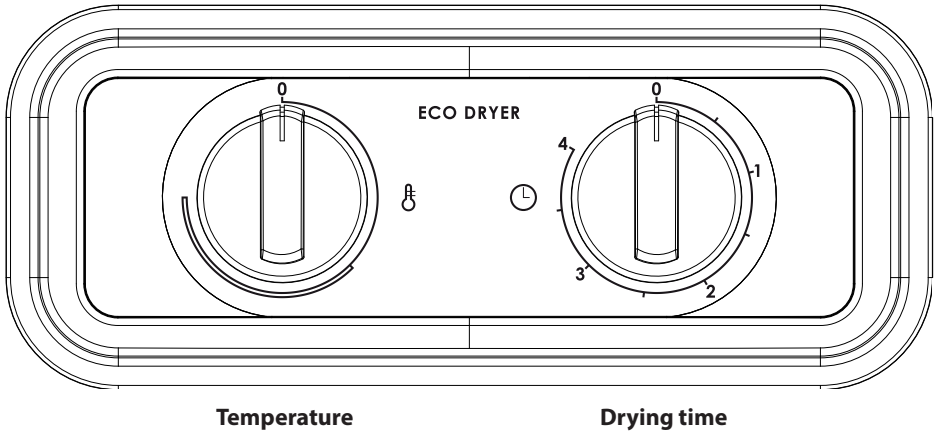

## SETTINGS

The cabinet is provided with two selector knobs for setting the positions for different power modes.

The left selector knob regulates heat on a continuous scale.

The right selector knob regulates drying time on a continuous scale up to four hours.

If a quick drying result is needed, turn the temperature selector knob to its maximum and set the timer to two hours. For a more normal drying time, the temperature selector knob is set to a point immediately after the beginning of the semi-circle and the timer between three and four hours. This means considerably lower energy consumption.

**CLEANING**

**NOTE** *High-pressure cleaning should not be used!*

- ❑ The walls of the cabinet should be cleaned with a mild soap solution on a damp cloth.
- ❑ Dust frequently gathers around the air intake orifice under the cabinet and on the upper part of the cabinet. This can disrupt operation of the cabinet, leading to stoppages.

To avoid this problem, the dust should be removed by suction from the air intake orifice and the top of the cabinet at least once a year or more often depending on the environment the cabinet is located in.

**SERVICE**

**Before contacting Service**, you should find out the name, article and serial number of the cabinet.

This information can be found on the data plate located inside the cabinet.

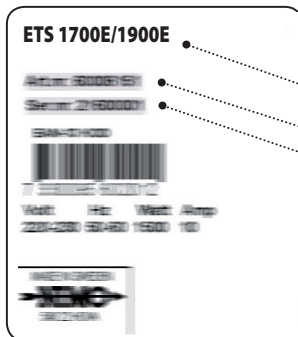
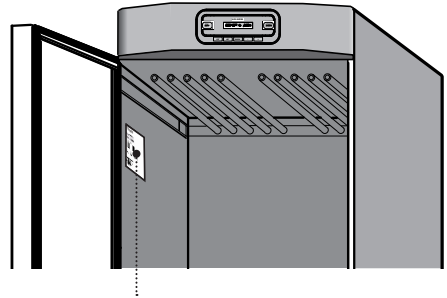

- Name of the drying cabinet*
- Article number*
- Serial number (12 digits)*

*Follow NIMO instructions when carrying out repairs or replacing parts.*

## TECHNICAL DATA    ETS 1700E / 1900E

<b>Capacity:</b>	approx. 4,0 kg washing (cotton)
<b>Dewatering capacity:</b>	4/10/17 g/min.
<b>Electrical connections:</b>	single-phase 230 V, 50-60 Hz
<b>Motor:</b>	35 W
<b>Heating element:</b>	750/1500 W
<b>Overheating cut-out:</b>	Yes
<b>Fan capacity:</b>	180 m <sup>3</sup> /h
<b>Hanging length:</b>	16 metres
<b>Dimensions:</b>	<i>Height:</i> ETS 1700E 1700 mm ETS 1900E 1900 mm <i>Depth:</i> 610 mm <i>Width:</i> 595 mm
<b>Weight:</b>	~54/56 kg
<b>Sound level:</b>	maximum 60 dB (A)

### MANUFACTURING STANDARD

See the identification plate

### ELECTRICAL DIAGRAM

The electrical circuit diagram can be ordered from the manufacturer. Address - see page 2.

## ENERGY CONSUMPTION AND DRYING TIME WHEN DRYING SPUN WASHING \*)

Programme	Energy consumption kWh/kg washing	Drying time	Temp. maximum
AUT 40°C	0.4	approx. 2 h	approx. 45°C
AUT 60°C	0.6	approx. 2 h	approx. 65°C
MAN 30°C	0.3 (2 h 30 min)	manual setting 15 min - 6 h	approx. 35°C
MAN 40°C	0.4 (2 h 30 min)	manual setting 15 min - 4 h	approx. 45°C
MAN 60°C	0.6 (2 h 30 min)	manual setting 15 min - 4 h	approx. 65°C
MAN -- °C	0.08 (8 h)	manual setting 15 min - 12 h	only fan

\*) Given values may vary depending on:  
- spin speed  
- temperature and air humidity in the room  
- air circulation in the room (supply air, exhaust air)



## TECHNICAL DATA ETS 1700 / 1900

<b>Capacity:</b>	approx. 4,0 kg washing (cotton)		
<b>Dewatering capacity:</b>	17 g/min.		
<b>Electrical connections:</b>	single-phase 230 V, 50-60 Hz		<b>MANUFACTURING STANDARD</b>
<b>Motor:</b>	35 W		See the identification plate
<b>Heating element:</b>	1500 W		
<b>Overheating cut-out:</b>	Yes		
<b>Timer:</b>	Can be set up to 4 hr		
<b>Fan capacity:</b>	180 m <sup>3</sup> /h		
<b>Hanging length:</b>	16 metres		<b>ELECTRICAL DIAGRAM</b>
<b>Dimensions:</b>	<i>Height:</i>	ETS 1700    1700 mm ETS 1900    1900 mm	The electrical circuit diagram can be ordered from the manufacturer. Address - see page 2.
	<i>Depth:</i>	610 mm	
	<i>Width:</i>	595 mm	
<b>Weight:</b>	~54/56 kg		
<b>Sound level:</b>	maximum 60 dB (A)		

### ENERGY CONSUMPTION AND DRYING TIME WHEN DRYING SPUN WASHING \*)

Setting	Energy consumption kWh/kg washing	Drying time	Heat
Economy	0.5	<i>approx.</i> 3 h	45°C
Fast	0.7	<i>approx.</i> 2 h	60°C

\*) Given values may vary depending on:  
- spin speed  
- temperature and air humidity in the room  
- air circulation in the room (supply air, exhaust air)

# PARAMETER ADJUSTMENT ETS 1700E / 1900E

## INTRODUCTION

The drying cabinet has **two automatic programmes, one for 40 °C and one for 60 °C.**

The automatic programmes **end when the washing is dry.**

To determine when the washing is dry, the programmes measure the temperature in the exhaust duct of the drying cabinet and compare it with a parameter set at the factory,

parameter **P4** for the 40 °C programme and

parameter **P8** for the 60 °C programme.

*These are the two main parameters to be adjusted to optimise the drying process of the automatic programme.*

- ❑ If you think that the washing is not being sufficiently dried, increase the value of the parameter for the relevant programme.
- ❑ If you think that the washing is being over-dried (long drying time), reduce the value of the parameter for the relevant programme.

Drying processes should always be optimised in small steps. Begin by adjusting the relevant parameter up or down by 1 to 2 units. Then check the result after the next drying process and adjust further if necessary.

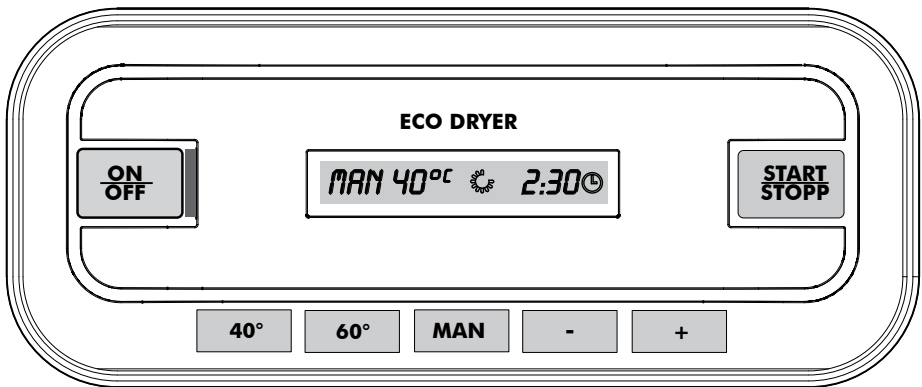

## PARAMETER ADJUSTMENT ETS 1700E / 1900E

---

### PARAMETER ADJUSTMENT

Use the control panel to access the parameter list of the drying cabinet. The parameter list appears one line at a time on the control panel display.

#### **Procedure:**

- 1 Make sure that the main **ON/OFF** switch of the drying cabinet is off and that the indicator ( item 2) is also off.
- 2 Hold down the minus “-” and plus “+” buttons and set the main **ON/OFF** switch to “**ON**”. This is indicated by a green light . The display lights up and shows “**P1**” (parameter 1) and the factory setting for **P1**.
- 3 Press the “**MAN**” button several times to step to the required parameter. If you overshoot, continue pressing until the display shows the correct parameter.
- 4 When the display shows the correct parameter (**P8**, for example), use the plus and minus buttons to increase or reduce the setting.
- 5 To save the settings and return to operating mode, press the **START/STOP** button. The display now shows the last programme used.

#### **NOTE: How to restore the parameters to the factory settings:**

- 1 Go to parameter display mode as explained at steps 1 and 2 above.
- 2 Hold down the “**40°**” button and press the **START/STOP** button. The parameter list re-appears and the display shows Parameter 1 and the factory setting for **P1**.
- 3 To save the factory settings and return to operating mode, press the **START/STOP** button. The display now shows the last programme

